

A hand holding a piece of wood. The hand is rendered in a semi-transparent, light gray material, showing the fingers gripping a dark, textured piece of wood. The wood has a visible grain and is held in a way that suggests it is being worked or shaped. The background is a plain, light color.

lzf
HANDMADE

TILT
Book

pdf

2012

Wood touched by Light



Victor Carrasco

Tilt, an acquired pose

Designed by Spaniard Victor Carrasco, Tilt has an unmistakable form lent to it by the unique combination of volumes, where the shade, on top of the structure, tilts intentionally to one side.

The result is a light sculpture which is easily integrated in most interiors, from private homes to public places. Its different versions cover all the needs of indirect lighting.

Tilt, postura voluntaria

La colección Tilt está diseñada por Víctor Carrasco. Su forma es inconfundible gracias a ese juego de volúmenes en el que la pantalla que corona, se ladea intencionadamente.

El resultado final es una escultura de luz que se integra con naturalidad en todo tipo de ambientes, desde hogares hasta instalaciones. Las diferentes versiones de la familia Tilt abrazan todas las necesidades de iluminación indirecta.

TILT Victor Carrasco



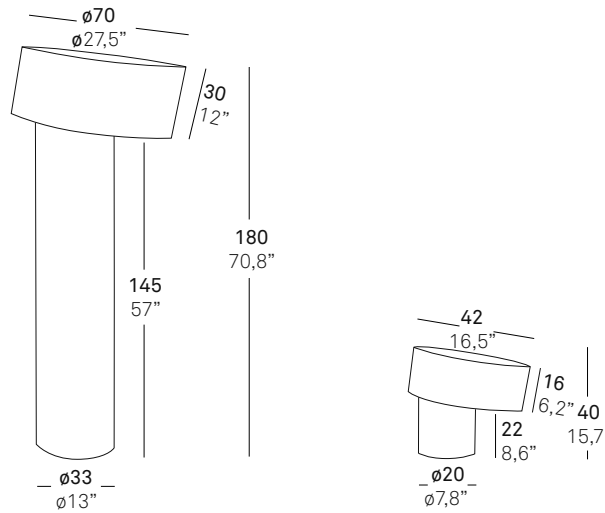





FAMILY / FAMILIA



SHADE FINISHES / ACABADOS PANTALLAS

REF. CHW

Natural timber veneer **Madera natural**

	CHW-20 American white wood Bolivar blanco		CHW-25 Orange Naranja
	CHW-21 Cherry Cerezo		CHW-26 Red Roja
	CHW-22 Beech Haya		CHW-27 Green Verde
	CHW-24 Yellow Amarillo		CHW-29 Grey Gris



Tilt
Victor Carrasco

TILT Victor Carrasco

FLOOR PIE	INFO	Electrical	Packaging	Dimension
-----------	------	------------	-----------	-----------

TILT P CHW



Shade / Pantalla
 Natural wood / **Madera natural**
 CHW colors:
 Floor / Pie
 20 21
 Table / Mesa
 20 21 22 24
 25 26 27 29
 see chart / ver gráfico

Diffuser / Difusor
 opal acrylic / **metacrilato opal**

Required / **Requiere**
 shade to base
 mount / **montaje de**
 pantalla a base

WORLD
 4 x 20 w
 E-27 Ø95
 CFL Double tube / **Bajo consumo**

USA
 4 x Spiral CFL 18W
 GU-24 Base

Shade / **Pantalla**
 Box 1 / **Caja 1:**
 7 Kg
 0,225 m³
 75x75x40 cm
Foot / Pie
 Box 2 / **Caja 2:**
 15 Kg
 0,450 m³
 50x50x180 cm

Shade (box 1)
 19 Lb
 Box size:
 30x30x16"
 Foot (box 2)
 30 Lb
 Box size:
 20x20x71"

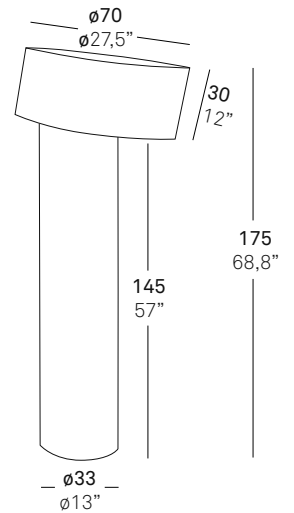

TABLE MESA

TILT M CHW



Family / **Familia**
 floor and table / **pie y mesa**

WORLD
 1 x 11 w
 E-27
 CFL short
 Double tube / **Bajo consumo**

USA
 1 x Spiral CFL 11W
 GU-24 Base

Box / **Caja:**
 4 Kg
 0,157 m³

31 Lb
 Box size:
 20x20x24"

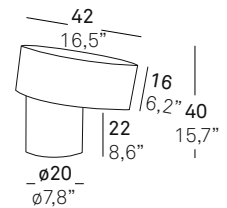





Tilt
Victor Carrasco



Tilt
Victor Carrasco



Tilt
Victor Carrasco

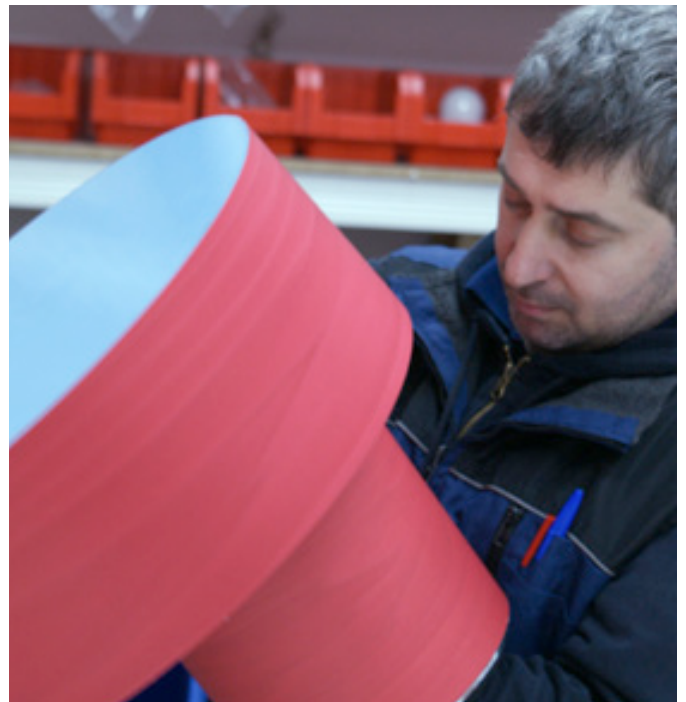

Tilt
Victor Carrasco



Luzifer Lamps



Tilt
Victor Carrasco



SPANISH
ARTISAN
OF THE YEAR
AWARD 2011